

Faeron Behavioral Health



Faeron Behavioral Health Guest & Patient

Krug, in consultation with senior healthcare designers and clinicians, has developed a series of highly functional, extremely durable, easily cleanable, attractive behavioral healthcare furniture solutions containing numerous security features including; ligature and elopement resistant designs, soft edges, restricted access points, tamper resistant hardware and supplemental weight for enhanced patient and staff safety.





Faeron Behavioral Health Multiple Seating

Faeron Behavioral Health is available with additional safety features such as supplemental weight, under-seat shields and anchoring hardware. Faeron Behavioral Health Lounge is a superior choice for dayrooms, activity areas, intake spaces and lobbies. The offering coordinates seamlessly with Faeron Behavioral Health guest and patient seating as well as Zola Behavioral Health tables. Weight ratings range from 500 lbs.-1200 lbs.



The fulsome Faeron Behavioral Health offering includes a broad range of options for dayroom, dining, and activity areas as well as intake, consult spaces and patient rooms. Almost all major components are field replaceable, ensuring minimal down-time for repairs and exceptional ROI.

Faeron Behavioral Health





Open Arm



Closed Arm



Two Panel Fully Closed Arm



Single Panel Fully Closed Arm

Faeron Behavioral Health Guest & Patient Arm Styles





Faeron Behavioral Health Lounge

A powerful blend of form and function, Faeron Behavioral Health Lounge combines an attractive residential look with uncompromising safety features including; anti-ligature design, soft edges, supplemental weight, tamper resistant hardware and staple covers, restricted access points and anti-ligature features for the safety and security of patients and staff.



Faeron Guest

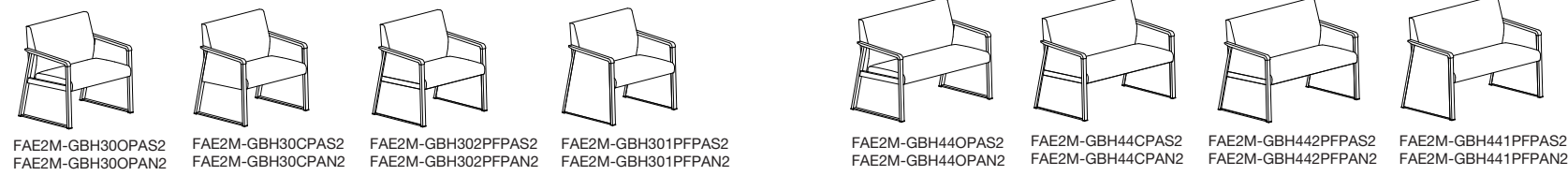
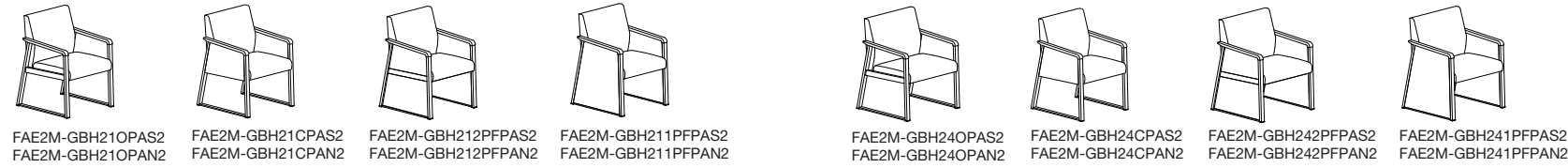

Faeron Patient

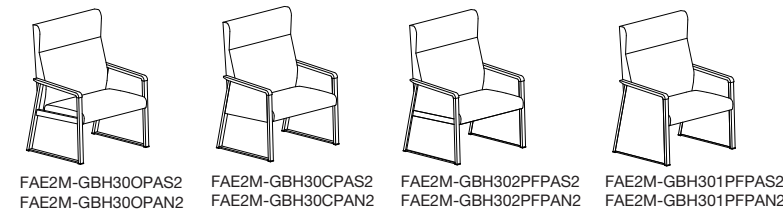
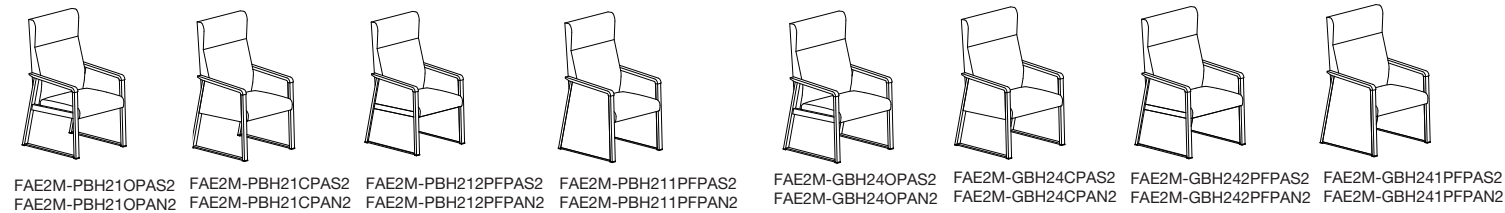

Faeron Multiple Seating (also available in Patient back)

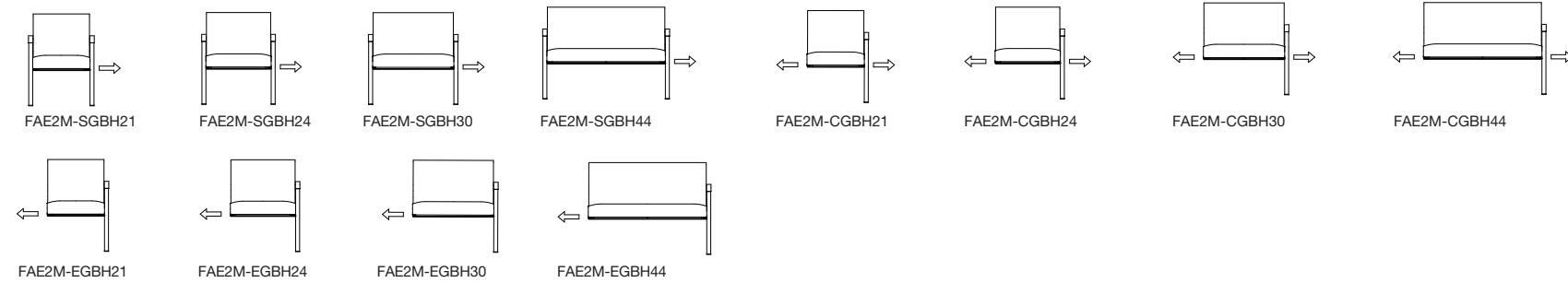

Faeron Lounge

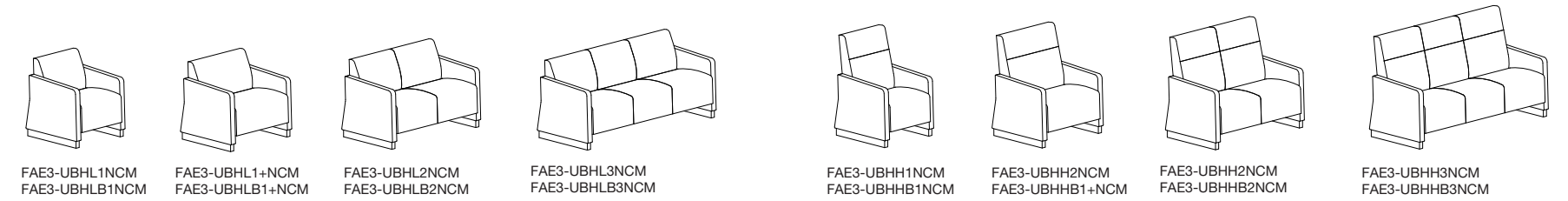
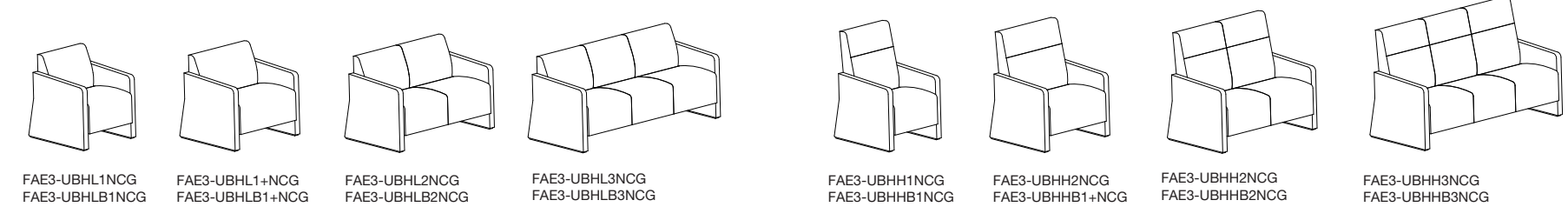
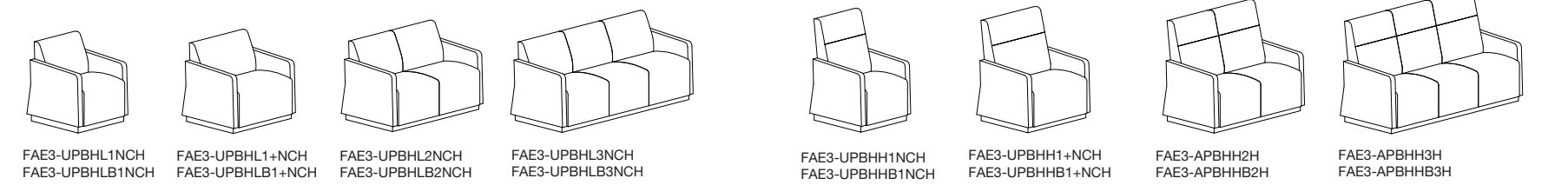
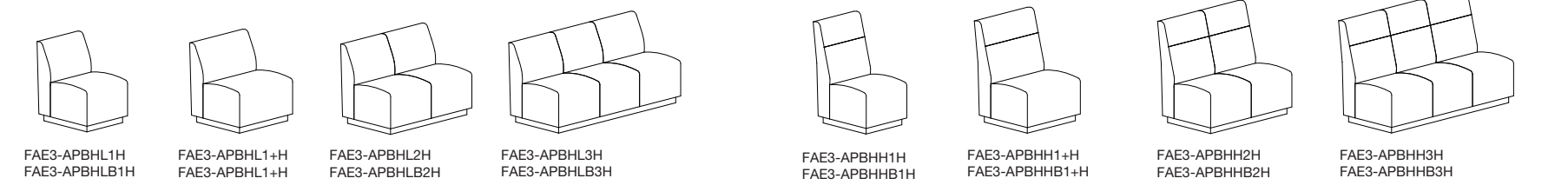

Zola Behavioral Health Tables | Perfect solution to accompany Faeron Behavioral Health Seating

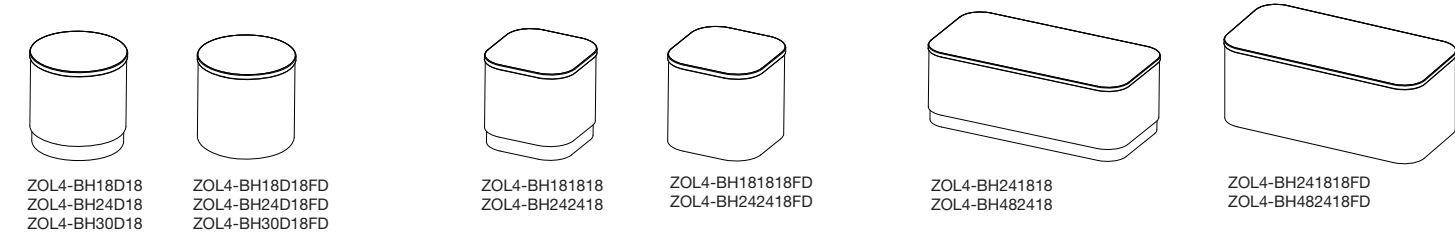

**WALL SAVER**

The angle of the back and the rear legs are designed to keep the back away from the wall, to prevent wear and damage to both the chairs and to the walls of the facility.

**FLEX BACK**

The ergonomically-designed back has a slight flexing action, which significantly enhances comfort.

**SLED BASE**

The Faeron side frames legs have the option to be tied front to back with a steel rail, this will strengthen the frames and eliminate the option of having legs.

**TAMPER RESISTANT HARDWARE**

All screws used on the Faeron Behavioral Health units have been replaced with tamper resistant security screws.

**SOLID SURFACE ARM**

Optional Solid Surface Arms provide a fully seamless, durable, easy to clean armrest. Available in 8 standard Corian colors and replaceable as a full side frame.

**SECURED WOODEN ARM**

Faeron Wood Arm caps are fastened to the side frames with tamper resistant security screws. Wood arms are available in solid beech hardwood and in 22 Krug standard finishes.

**NO SPRING SEATS**

With this option the springs in the seat are removed and replaced with a solid plywood seat pan, additional foam has also been added in place of the springs for comfort.

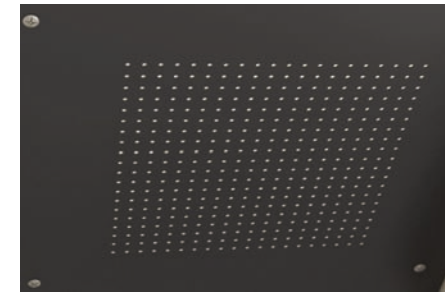
**WEIGHTED SHIELD**

This steel shield option is designed to add enough weight for the product to be a minimum of 80 lbs.

**CLEAN OUT**

A clean-out space between the seat and back makes for easier cleaning and maintenance.

**SECURED GLIDES**

Faeron Behavioral Health chairs have their glides secured in place to prevent their removal and damage.

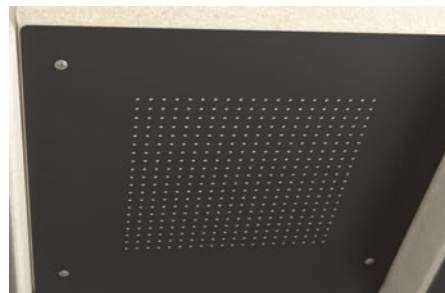
**BOTTOM STAPLE COVER/SHIELD**

This cover is designed to prevent access to the upholstery staples of the seat and to prevent the hiding of objects underneath the seat. The cover is also designed to allow for regular ganging hardware and proper seat ventilation.

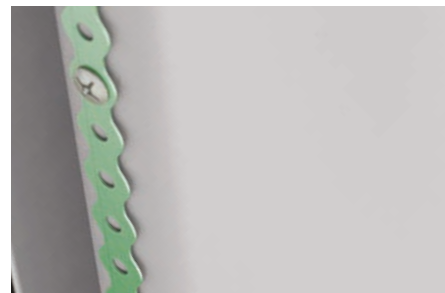
**BACK STAPLE COVER STRIP**

Faeron Behavioral Health back upholstery has been altered to allow a staple cover strip to be attached; this will prevent access to the upholstery staples. The cover strip is nylon coated galvanized steel with vinyl coated ends to prevent any sharp edges.

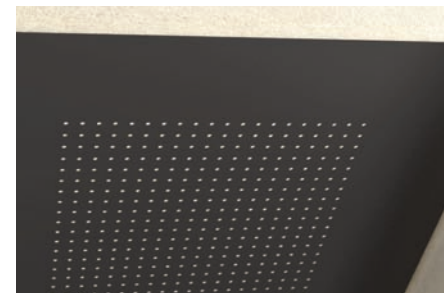
**TAMPER-RESISTANT SPLASHGUARD**

All Faeron seating models are available with a coated steel moisture barrier that covers and enclosed the underside of the seat (while still allowing air transfer and ventilation in and out of the seat cushion).

**FLOOR ANCHOR BRACKETS**

Floor mounting brackets are supplied to be secured to the bottom of the Faeron sleigh base with tamper resistant security screws. (The hardware to attach the brackets to the floor is not provided by Krug.)

**KINETIC BACK**

This optional feature provides the chair back with a very pleasant and comfortable rocking motion, which can significantly enhance long-term sitting for patients and guests. The durable spring-loaded mechanism provides a range of motion of 20 degrees, and can be field-installed or replaced.

**COMBINATION UPHOLSTERY**

Combination upholstery option includes more than one upholstery cover within the same unit. Back, Seat, Closed or Semi-closed arm can be specified in a different fabric selection.

URETHANE/POLYMER COLOR OPTIONS



Taupe



Black



Grey

METAL FINISH - Standard

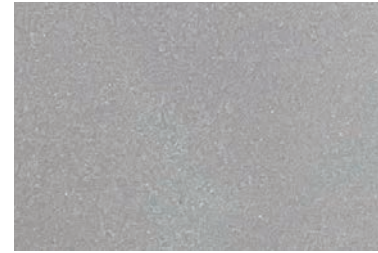

Silver Metallic

METAL FINISH - Optional



Brushed Nickel

METAL FINISH - Optional (with minimum order quantity)

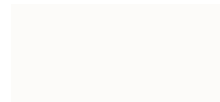

White

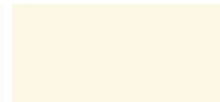

Parchment



Sand



Taupe



Warm Grey



Cool Grey



Black

SOLID SURFACE

GROUP GRADE A - WHITE

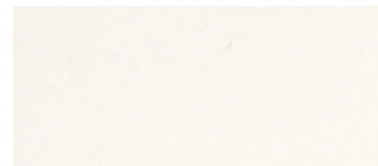

Glacier White

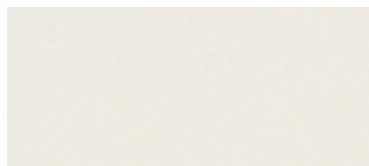

Cameo White

GROUP GRADE A - COLOR



Bisque



Linen

GROUP GRADE B



Antarctica

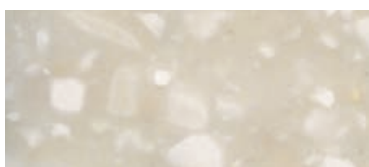

Savannah

GROUP GRADE C

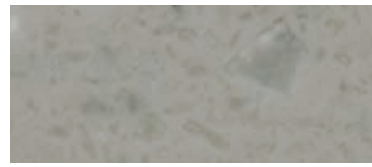

Dove

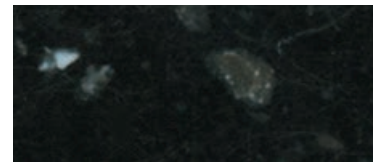

Deep Night Sky



Zola Behavioral Health Tables

Perfect solution to accompany Faeron Behavioral Health Seating



Faeron Environmental

The use of recycled and recyclable materials, combined with environmentally-friendly production processes and packaging, have made Faeron a level™-certified product, and a contributor to LEED™-driven specifications. Faeron is certified by the Greenguard™ standard for indoor air emissions, and it's unique capability for extending product life makes it a responsible environmental choice - and one that will provide exceptional return on investment over time.



All products are air emissions certified and are available as FSC® certified

krug HEALTHCARE

solutions@krug.ca | www.krug.ca | 1.888.578.KRUG